

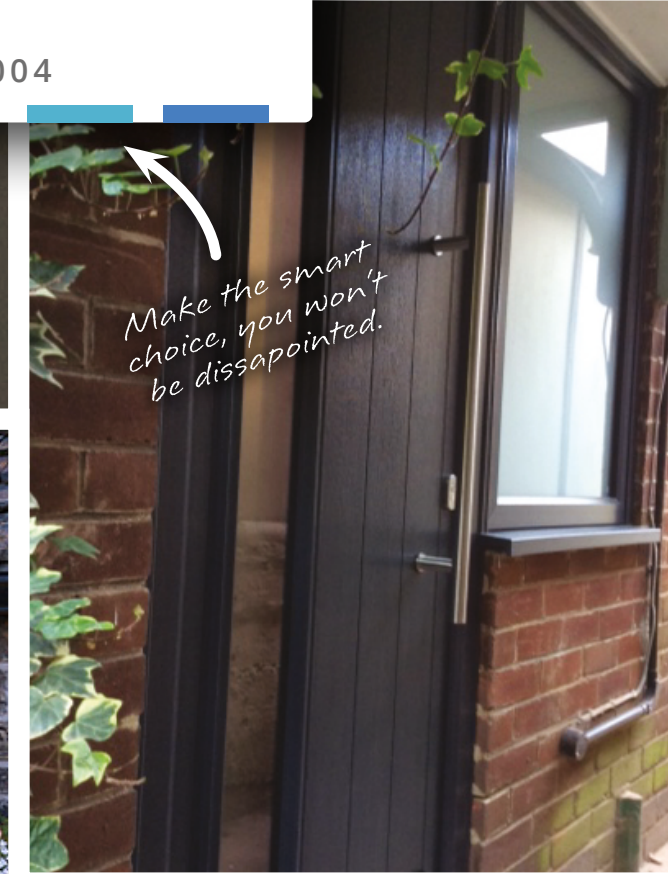



smartglaze
HOME IMPROVEMENTS LTD

'The Smart Choice'

ESTABLISHED 2004



INDEX

■ 3	Mission Statement
■ 5	Composite Doors
■ 8	Bi-Fold Doors
■ 10	Patio & French Doors
■ 11	Stable Doors & Arch
■ 12	Windows
■ 13	Tilt & Turn Windows / Glass with Integral Blinds
■ 14	French & Sliding Sash Windows
■ 15	Mock Sash Horn Windows
■ 16	Casement Windows & Georgian Bar
■ 17	Bay Windows
■ 18	R7 - Residence 7 Window Option
■ 20-23	Conservatories
■ 24	Pilkington Activ Self Cleaning Glass
■ 25-27	Warmer Roofs
■ 28	Flat Roofs - Rubber Roofs & Permaroof-500
■ 29	Fascias, Soffits & Guttering
■ 30-31	Sky Pods
■ 32-33	Porches
■ 34	Garden or Green Rooms
■ 35	Shop Fronts
■ 36-37	Our Team in Action
■ 38	Design & Styling
■ 40	Colour Ranges
■ 41	Glass Designs
■ 42	Obscure Glass Finishes
■ 43	Door Accessories
■ 44	Casement & Window Designs
■ 45	Threshold & Cill Options
■ 46	Back Doors & Half Panels
■ 47	Certificates



OUR MISSION STATEMENT

Our aim as a local company is to provide friendly, quality services that can be relied upon, with the same attention to workmanship from concept to completion. Backed-up with a fast response to post installation care in the unlikely event that there are any problems.



See more of our team in action on pages 36 & 37

smartglaze:

ESTABLISHED 2004

Smartglaze Home Improvements have been improving homes since 2004 and with over 20 years experience, you can be rest assured that not only will we install the highest quality products available but you will also receive friendly, helpful and professional advice too.

QUALITY MATTERS

We believe that quality always costs less in the longrun. All of our installations and products carry a 10 year guarantee and for added piece of mind we offer a 10 year insurance backed guarantee at no extra cost.

EXCELLENCE AS STANDARD

We are so proud of our reputation and installations, that any of our work is viewable on request. In turn, all of our installations are recorded with Derbyshire County Councils Trusted Traded Scheme.





**AT SMARTGLAZE WE UNDERSTAND
THAT EVERY HOME IS DIFFERENT.**

Choosing the correct door can reflect the style and period of your home. Our choice and styles of doors are second to none and we can make sure you get all the advice you need to choose the right door. Our fitting service will ensure a professional and speedy service.



We are a recommended
Entrance Installer

The most
Secure Door
on the market

Featuring a 48mm thick solid timber core and fitted with the Ultion lock, Entrance is the UK's most secure composite door. No home should be without one.



ENTRANCE COMPOSITE DOORS

We have an unrivalled range of composite doors to really make a statement at your home. A composite door is filled with timber, unlike traditional doors making it the most solid door on the market. They come in a huge range of colours and styles making them perfect for any home.

View our full Entrance Brochure at: www.smartglaze.co.uk





Introducing the Ultion KeyTag

Upgrade your standard Ultion key with the Ultion KeyTag, you'll never have to look for your keys anymore. Instead of opening drawers and checking pockets and purses, all you have to do is press a button on the Apple Find My app (or, if you prefer to do it hands-free, just ask, "Siri, where are my keys?").

Your keys are going to sound an alarm indicating their position, Still not sure where they are? The Apple Find My app will show on your mobile the exact location of the would-be lost keys, or where they were last time they were near an Apple device.

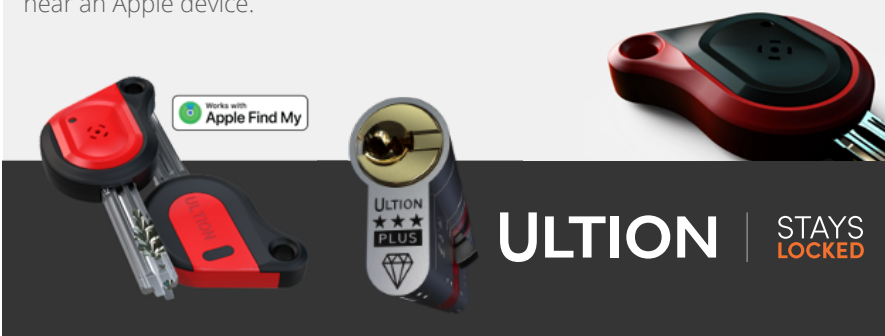

Scan below to view the latest Entrance brochure



Or scan below to begin your door build journey...





BI-FOLD DOORS

A bi-folding door is the best way to open up your home, let in more light and make your home feel and look bigger. These doors offer the latest in security and energy efficiency. Bi-folding doors stack in a space efficient way giving that extra space that a patio door just cannot manage. You can choose whether they stack right or left and even inside or outside your home.



Suit your desires, the following are a few options of bi-fold designs for your home.

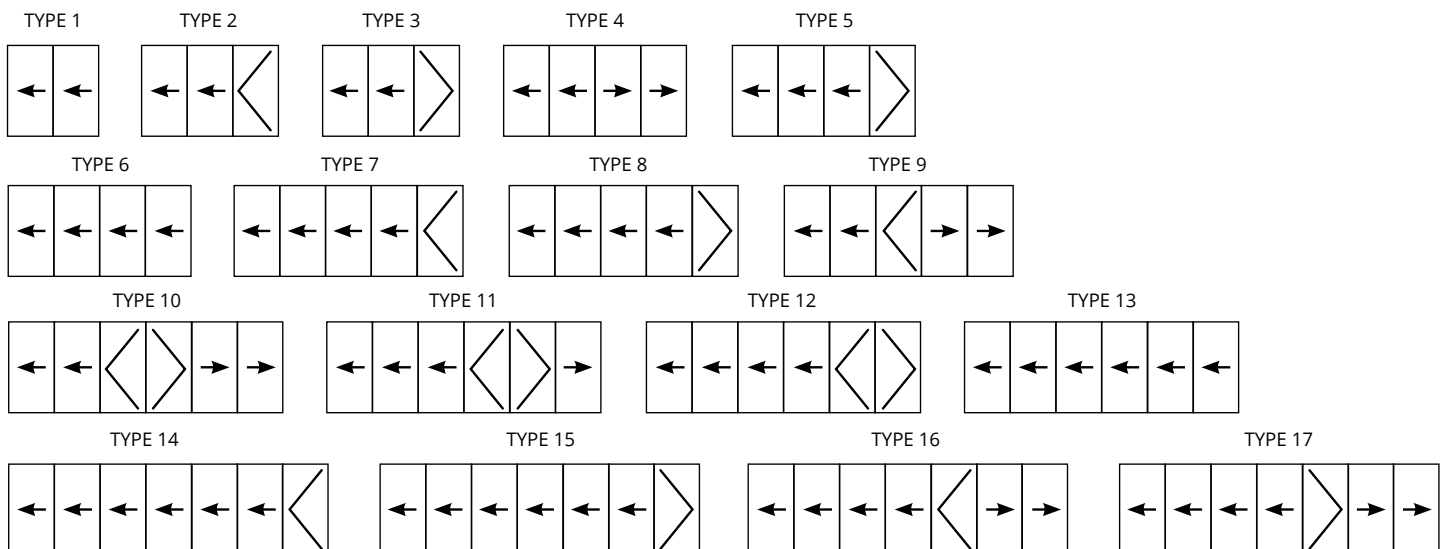



PATIO DOORS

Our patio doors are modern, energy efficient and high in security. Perfect for homes looking to add more light and access, our patio doors are available in a range of styles and colours including wood grain effect or traditional white UPVC.



FRENCH DOORS

A French door is the best way to open up your home, let in more light and make your home feel and look bigger. These doors offer the latest in security and energy efficiency, our French doors are available in a range of styles and colours.



STABLE DOORS

All of our standard range and many of our Italia collection door styles can be integrated into a beautiful stable door and you can even benefit from different colours inside and out. All of our stable doors come with high security, fully adjustable, multipoint locking system. A security interlocking door bolt to secure the top and bottom halves of the door together. Our Stable Doors can be supplied in UPVC and composite.



UPVC Option 70/30 split



UPVC Option 70/30 split



Composite Option 50/50 split



UPVC Option 70/30 split



Composite Option 50/50 split

ARCH DOORS. Just a few arch door options.

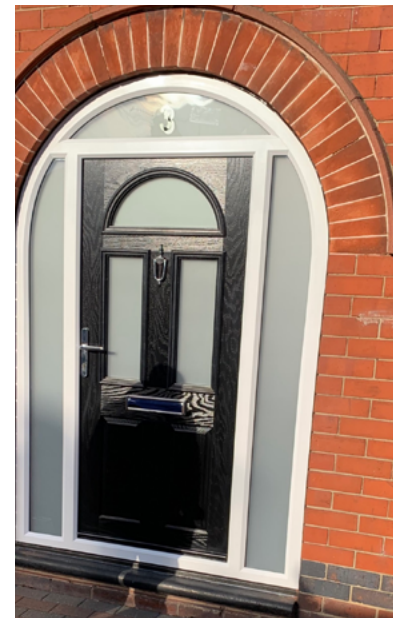

smartglaze:WINDOWS



WINDOWS

Smartglaze have a wide range of windows to choose from to suit any home.

Choosing the best windows for your home can be a confusing job, with so many styles and finishes on the market. At Smartglaze we cut through all the hard sell and give you the exact information you need.

A RATED GLASS AS STANDARD

28mm thick insulated double glazed units are fitted as standard for thermal efficiency*.

Opening frames are fully weather-stripped and reinforced with 100% recycled PVC-U bars for added strength and increased thermal performance.

Glazing beads are fitted internally for extra security.

Outer frames measure 70mm front-to-back for easy replacement, and profiles are multi-chambered to prevent heat loss.

Triple Glazed units also available

smartglaze:SOMETHING TO THINK ABOUT



TURN & TILT WINDOWS

These windows offer great access for cleaning purposes, ideally placed above a single storey extension

NOTE: Tilt & Turn always open inwards.

GLASS WITH INTEGRAL BLINDS

These are an excellent idea if you were planning on having blinds, this design cleverly integrates the blinds in-between the double glazing giving you a perfect blind with no cleaning required.

Available in a range of colours to suit your decoration.

BLIND COLOUR CHOICES:



FRENCH WINDOWS

French windows are a great option if you are limited on space or have a narrow opening area.



SLIDING SASH WINDOWS

We offer the charm and traditional style of a sliding sash window. Retaining all the period charm, delivered at a competitive price.



Inside view in the tilt position



MOCK SASH HORN WINDOWS

A great cheaper alternative is the mock sash window. Offering the same period charm of a traditional sliding sash window, but with the benefit of a regular opening window.



CASEMENT WINDOWS

For many reasons Casement windows are one of the most popular types of windows in the UK today. Casement are windows that have one or more hinges that attach them to the window frame. This simple hinge design gives them very little reason to damage or break.

Smartglaze can craft casement windows to any size that you wish and that includes horizontal or vertical opening as well as single panels or double panels that open inwardly together.



Casement dummy sash windows designed to give a flush finish, rather than having a recess on the middle window.

GEORGIAN BAR OPTIONS

All products available in a wide selection



BAY WINDOWS

Classic Bay windows provide wide, un-obstructed views giving a real sense of spaciousness.

They make a beautiful choice for any home.

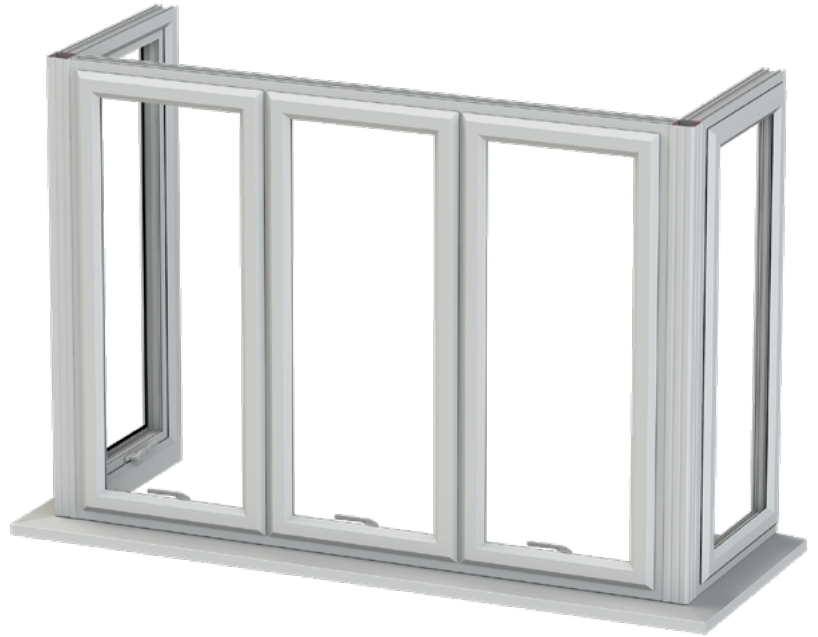

R7

RESIDENCE 7.

RESIDENCE 7

Residence 7 windows and doors are finished to perfection, combining a modern flush appearance and unquestionable market leading design features and performance, all in a maintenance free material. Available as casement windows, shaped windows, bay and bow windows, orangeries, conservatories, single doors and French doors - R7 has all the choices for your perfect home.



*"They have transformed
the look of our house"*

*"We couldn't be happier
with our new windows"*



smartglaze:CONSERVATORIES



THE BEST IN CONSERVATORIES

One of the easiest and cost efficient ways of improving your home is the addition of a conservatory. Our range of conservatories is second to none and we offer a professional advice service to help choose the right one for your home.

Whether you are looking for that extra light, a new office, dining area, play room or relaxing lounge, Smartglaze have the conservatory to fit the style and shape of your home.

PILKINGTON ACTIV™ SELF-CLEANING GLASS

After years of research and development leading glass manufacturer Pilkington has introduced the Pilkington Activ™ range of products. The range has products which combine both self-cleaning and solar control properties, making them highly desirable amongst homeowners looking for the ultimate in glass solutions.

smartglaze: SHAPED TO YOUR NEEDS



P & L SHAPED CONSERVATORIES

The P & L shaped conservatories are able to work with any space you have, and we have many ideas to help design the best solution to fit your requirements.



GABLE CONSERVATORY

The gable end conservatory suits all house types and adds that little luxury feel to it too. The look creates space, light and an all round touch of class. It is no wonder that the gable end conservatory is becoming more and more popular.

LEAN TO CONSERVATORIES

A lean to conservatory is the most versatile of all of the conservatory designs. It can be used where the height of the conservatory roof at the house wall is restricted, such as on a bungalow, or where a bedroom window is directly above the centre of the conservatory.



VICTORIAN & EDWARDIAN CONSERVATORIES



SOLAR GLASS ROOFS

These self cleaning solar glass roofs reflect heat back into your room in the winter and will not make your room feel like a green house in the summer time. Anyone with an existing conservatory can keep the existing frames and just replace the roof glass.



A FEW OF OUR CONSERVATORY IDEAS



TRANSFORM YOUR CONSERVATORY FROM THIS...



WARM IN WINTER

COOL IN SUMMER

SELF CLEANING

ENERGY EFFICIENT

REDUCE GLARE

10 YEAR GUARANTEE

Let us replace your old, tired looking conservatory roof and leave you with a new 'all year round' room that looks great and features high performance, easy clean glass.

What's more our experienced fitters will take just 2 days to transform your conservatory, using your existing base and leaving your decor and garden untouched!

PILKINGTON ACTIV™ SELF-CLEANING GLASS

After years of research and development leading glass manufacturer Pilkington has introduced the Pilkington Activ™ range of products. The range has products which combine both self-cleaning and solar control properties, making them highly desirable amongst homeowners looking for the ultimate in glass solutions.

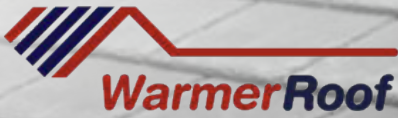

WARMER ROOFS

Enjoy the beauty, elegance and performance of the Warmer Roof System.

Designed to be used on new extensions or to replace your existing conservatory roof, creating a space that is useable all year-round with exceptional thermal qualities.

With stunning lightweight tiles, internal plastered ceiling and a range of personalised features, the Warmer Roof will add a modern space that no longer feels like a conservatory but part of your home.



BURNT UMBER



CHARCOAL

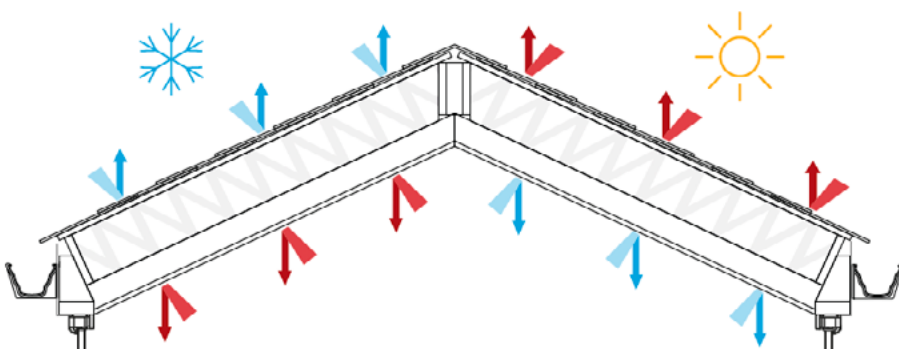

COLOUR OPTIONS



Antique Red



Charcoal

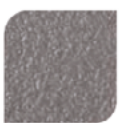

Mid Grey



Sage Green



Terracotta

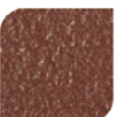

Tudor Brown



Internal roof insulation pre plastering.



THE INSTALLATION PROCESS

Removing the existing old conservatory.



Preparing the walls and ground for the new UPVC frames and glazing.



Roof pods aligned and ready for installation.



Roof pods being placed in position.



Roof Pods installed and ready for the lightweight tiles to be installed.



Finished result, a garden room that can be used all year round without being too hot or too cold.



smartglaze:FLAT ROOF OPTIONS



FLAT ROOF OPTIONS - RUBBER OR LIQUID

Smartglaze makes roofing easy.

We are certified installers of Permaroof Rubbercover & Liquid products. A fast and reliable installation process for house extensions verandas, garages, car ports, garden sheds and dormers.

Permaroof⁵⁰⁰
LIQUID COATINGS



Thinking of changing your **FASCIAS, SOFFITS & GUTTERING?**



We have our own scaffold so no need to pay out any extra cost on using another scaffold company.

We take off all the existing rotten timber. (We never go over the existing wood that leads to even more future rot.)

Licensed waste carriers so the majority of the time there is no need to have any skips on the drive.

Our under tiles fascia system is designed to stop birds going in your roof
Variety of colours to suit different styles of property.

Call us for a free no obligation quotation and free advice **01332 780125**
E: info@smartglaze.co.uk Based in Denby

Great customer care is a priority. Realistic quotations

See our Solidor composite door brochure online
www.smartglaze.co.uk



smartglaze:SKY PODS



SKY PODS

Become a stargazer with our stylish new skypod roof lights.

These beautiful new roofs will flood your home with natural light and bring your home a new contemporary feel. There's excellent energy efficiency too, not to mention a wide choice of colours.

We offer a wide range of glass options to bring the very best to each home! These skypods are the fastest and easiest roofs to install making them an ideal project for the home diy'er!

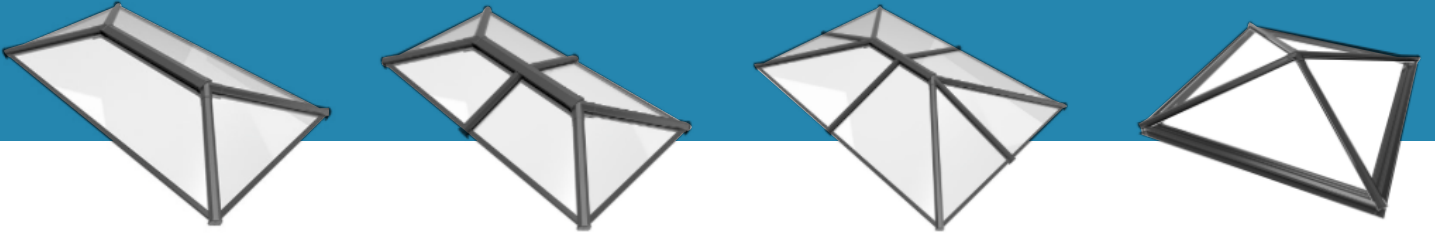

smartglaze:PORCH



PORCH OPTIONS

A Porch can improve your home in so many ways...

A home is a long term commitment and there are times, when improvements are needed. We have a wide range of services that we can offer to help improve you home. All our porches are made to measure for your home, we have a wide range of ideas and styles to meet your needs.

smartglaze:MADE TO MEASURE



Flat roof preparation



smartglaze:GARDEN ROOMS



UPVc roof consisting of a timber lower shell to give that rustic feel.

GARDEN ROOMS & MAN CAVE IDEAS

Why not escape the hustle and bustle of everyday life and relax in your own new garden room?

Our free-standing garden rooms and summer houses are made to measure to suit any space, so you can place them anywhere in your garden that suits you. Transform your new room into a garden bar, or simply use it as a place to relax and unwind. With our free-standing garden rooms and summer houses, you can create the perfect oasis in your own piece of paradise.

ADDING EXTRA ROOMS, ROOMS TO BE PROUD OF.

Here are examples of our freestanding garden rooms and greenhouses. An elegant and more substantial alternative to the usual light aluminium frame.



UPVC & ALUMINIUM COMMERCIAL SHOP FRONTS

Our products can also be utilised for commercial premises, to either rejuvenate an existing tired building or to completely replace windows and doors to bring your premises back to its former glory. .



OTHER SERVICES WE OFFER

- Repairs & Locks
- Cladding
- Condensated glass replacements
- Aluminium Products
- No pressure & No Salesmen

smartglaze:OUR TEAM IN ACTION

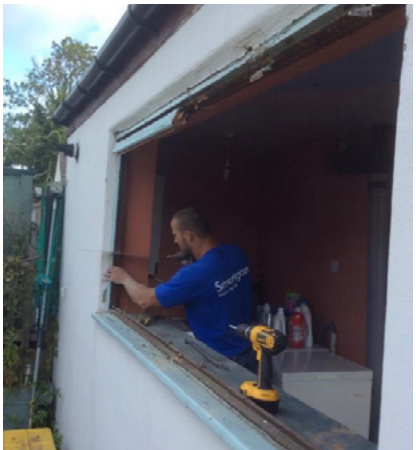





OUR COLOUR RANGE:

Please note: Non standard colours on products will have to be classed as a special item and be sent to be sprayed, this will add a delay to any potential installation date, and will add a surcharge for this service.

STANDARD COLOURS



White

Black

Blue

Red

Green

PAINTED RAL & RENOLIT COLOURS

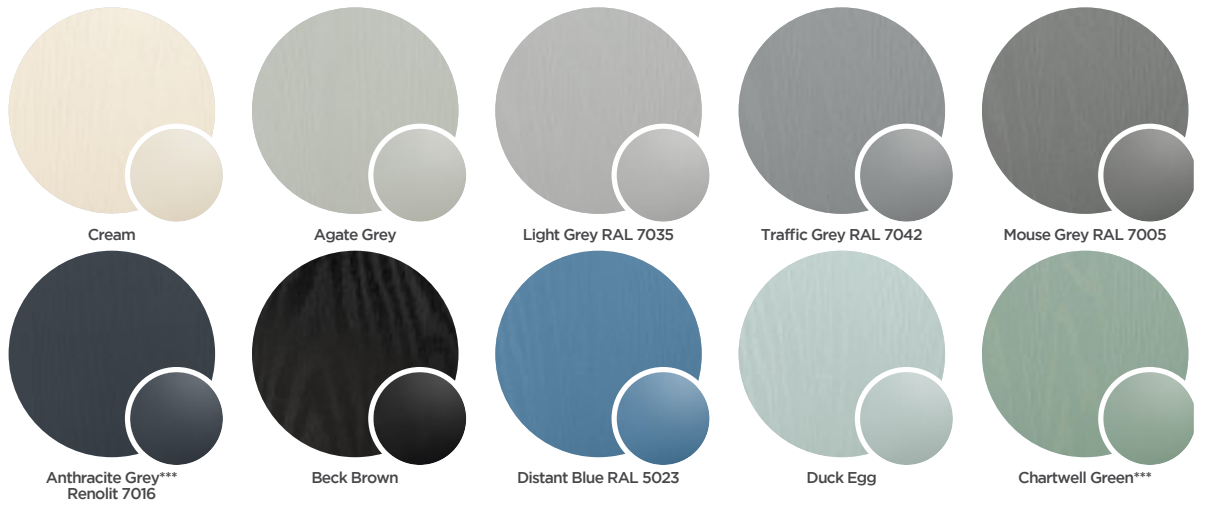

Cream

Agate Grey

Light Grey RAL 7035

Traffic Grey RAL 7042

Mouse Grey RAL 7005

Slate

Anthracite Grey***
Renolit 7016

Beck Brown

Distant Blue RAL 5023

Duck Egg

Chartwell Green***

EXCLUSIVE PAINT COLOURS

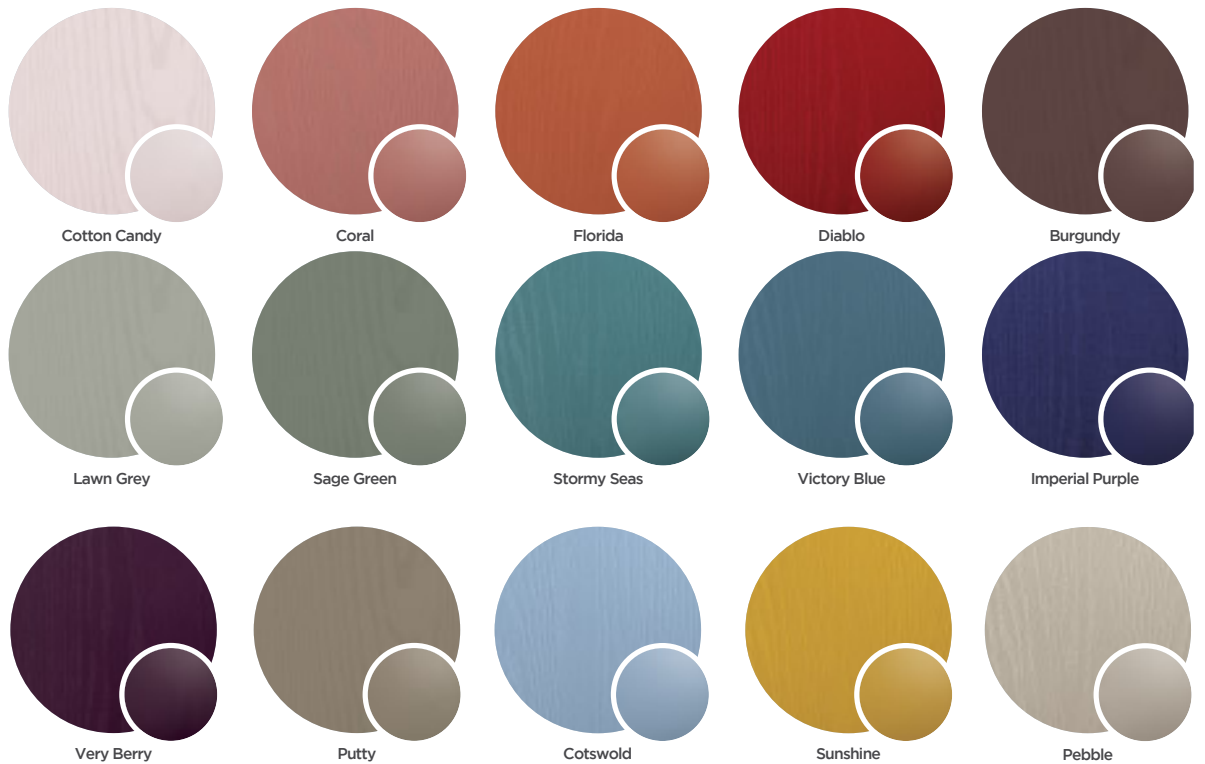

Cotton Candy

Coral

Florida

Diablo

Burgundy

Lawn Grey

Sage Green

Stormy Seas

Victory Blue

Imperial Purple

Very Berry

Putty

Cotswold

Sunshine

Pebble

A WIDE RANGE OF LEAD GLASS DESIGNS

Just a few of the popular lead designs available (other designs available please ask for our full brochure)

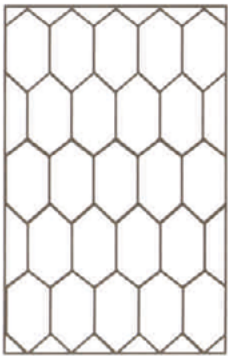

Jacobean

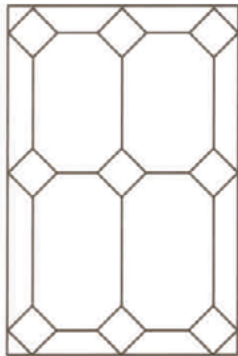

Hanover

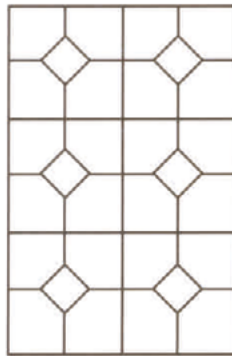

Queen Anne

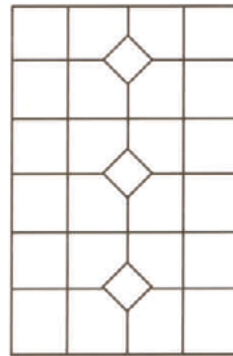

Queen Caroline

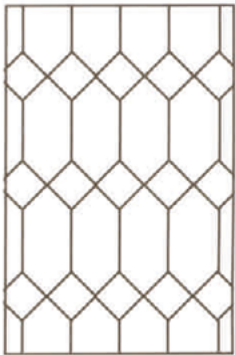

Stuart

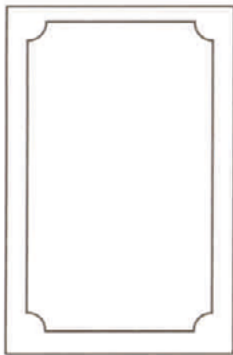

Single Cleveland

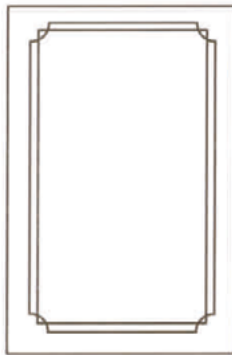

Double Cleveland

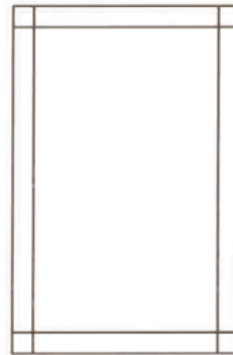

Single Northumberland

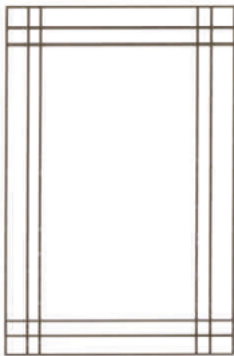

Double Northumberland



Diamond

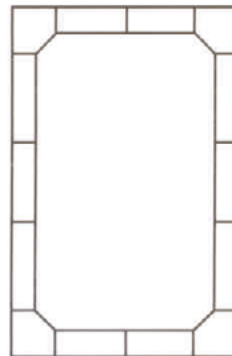

Regent

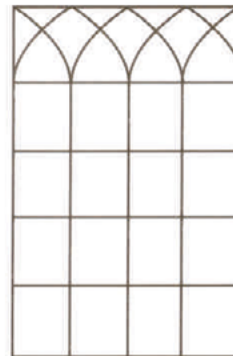

Gothic

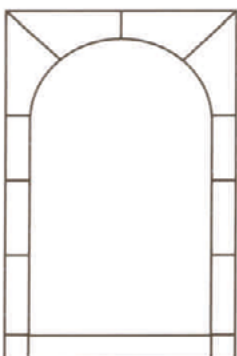

Arch

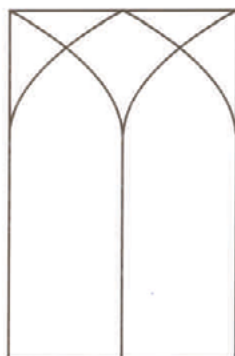

Arcade

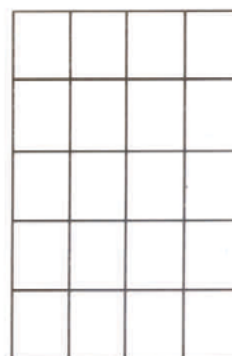

Rectangular

OBSCURE GLASS FINISHES

Just a few of the popular glass designs available (other designs available please ask for our Bevell brochure)

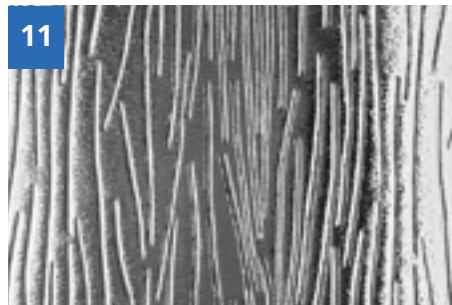
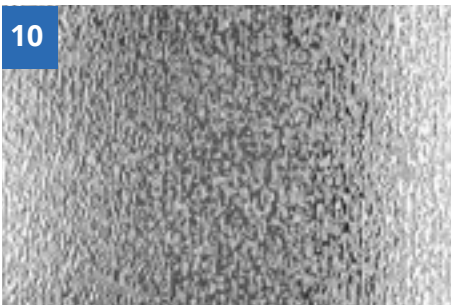
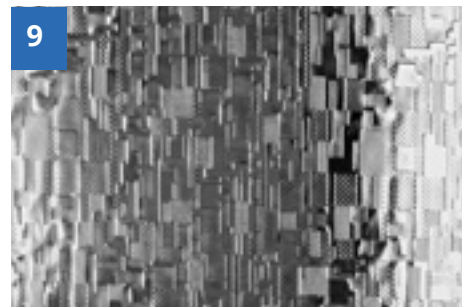
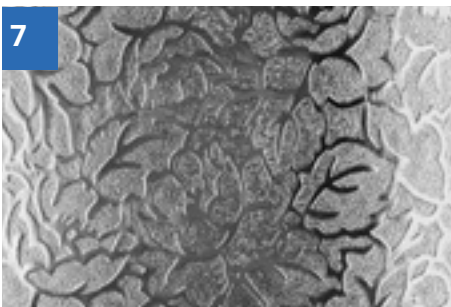
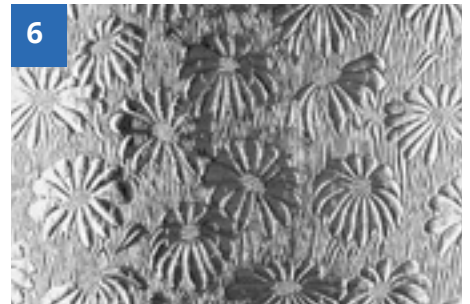
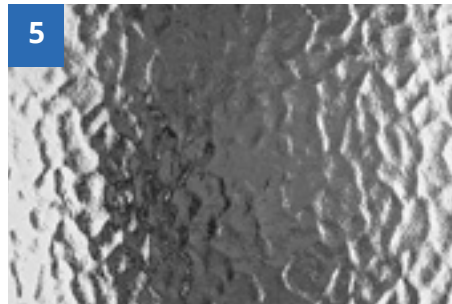
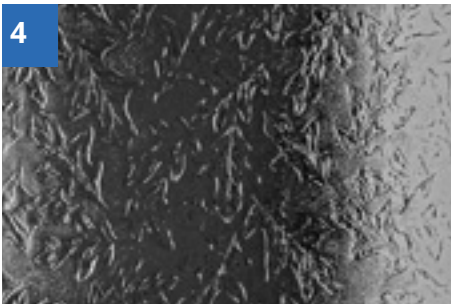
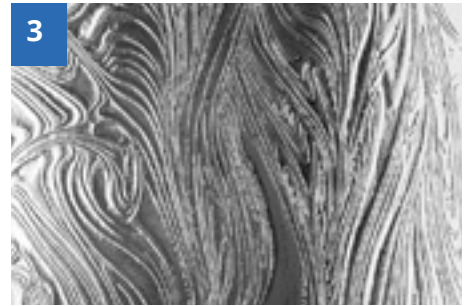
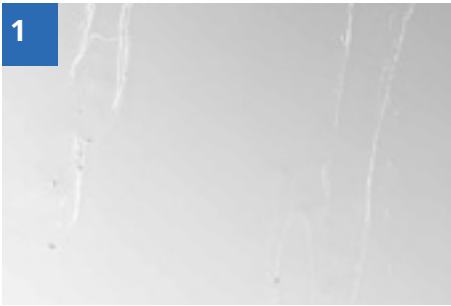

- 1 - Warwick
- 2 - Pelerine
- 3 - Tefetta
- 4 - Oak
- 5 - Minster

- 6 - May Flower
- 7 - Florielle
- 8 - Everglade
- 9 - Digital
- 10 - Contora

- 11 - Charcoal
- 12 - Chantilly
- 13 - Stippolyte
- 14 - Satin

ACCESSORIES

A fine selection of beautiful accessories to perfectly complement your choice of door. Whether modern or traditional you will find an accessory to really make your door stand out.

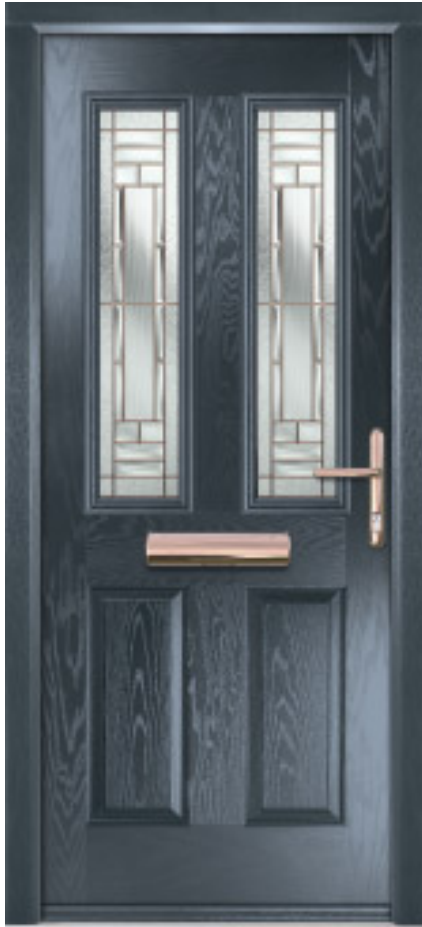

SAPPHIRE 2 | ROSE GOLD FINISH



BALMORAL
LEVER/LEVER



BALMORAL
PAD/LEVER



HERITAGE
LEVER/LEVER

For more handle options, please visit: www.entranceway.co.uk



SWEET
LEVER/LEVER



SWEET
LOCK LOCK

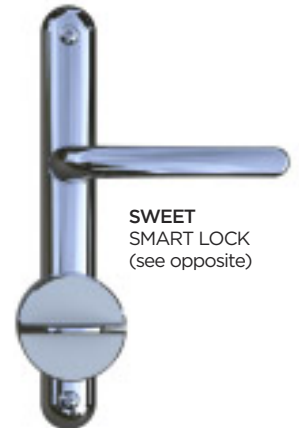

SWEET
SMART LOCK
(see opposite)

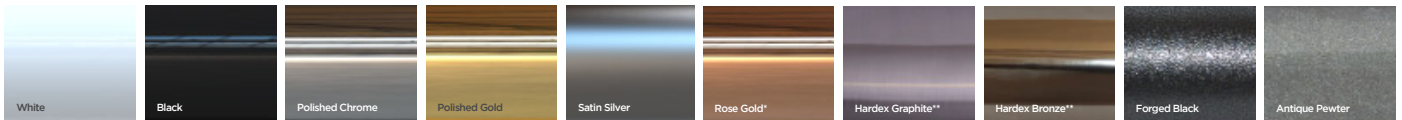

LETTERPLATES



DOOR KNOCKERS



NUMERALS



CENTRE KNOBS



A SELECTION OF CASEMENT & WINDOW DESIGNS

Other Options Are Available

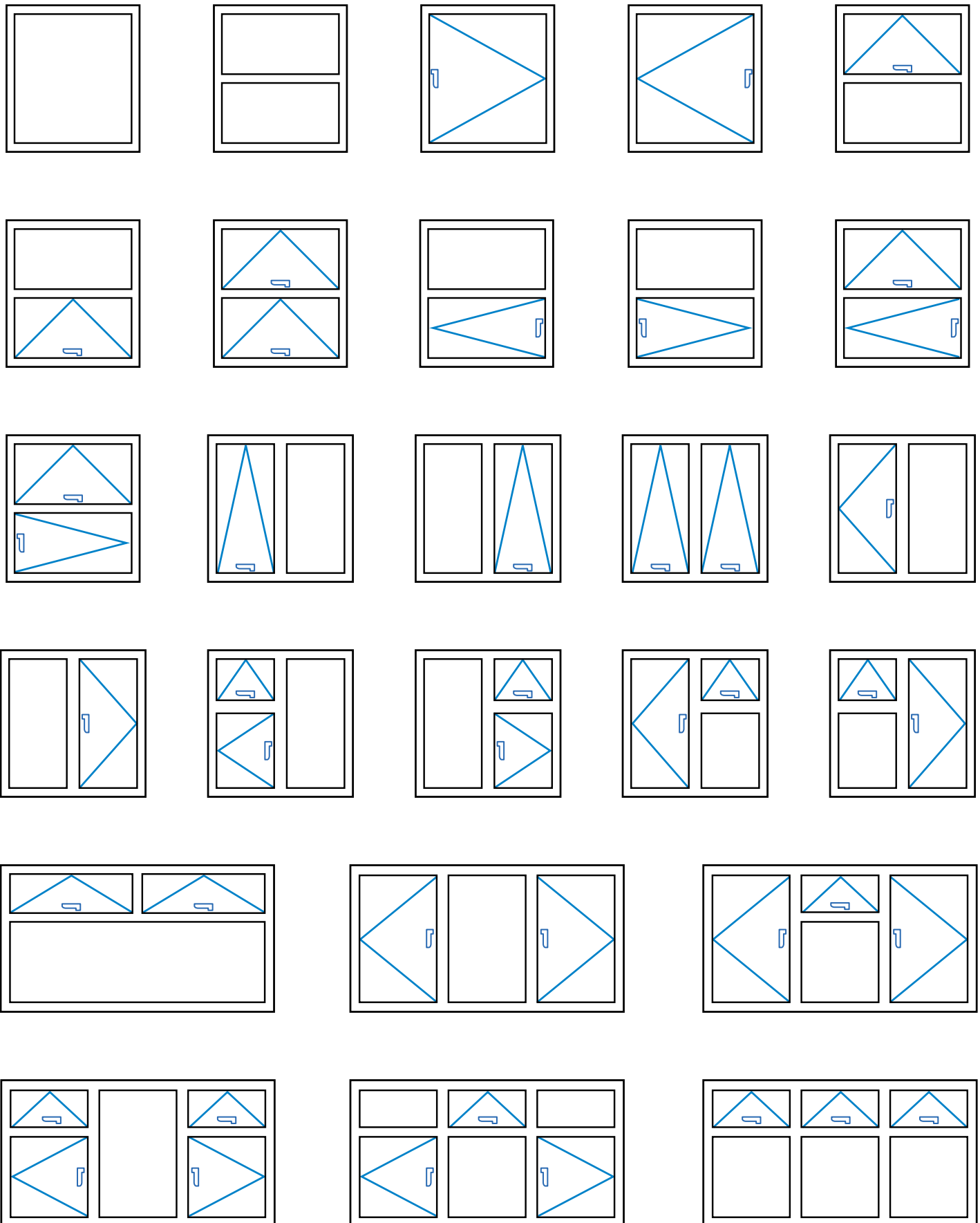

THRESHOLD & CILL OPTIONS

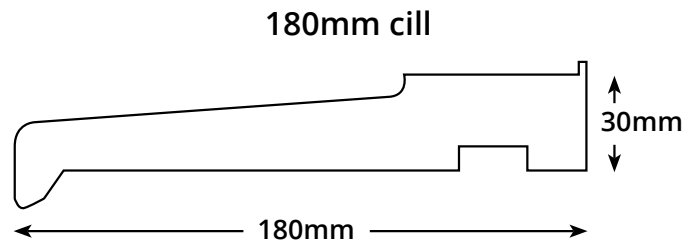
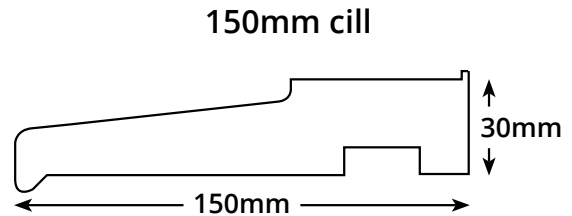
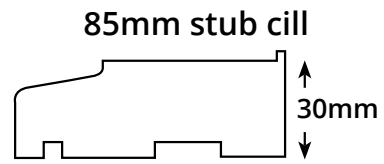

Face drainage is used when there is no need for a water drip cill.

WHEELCHAIR ACCESS OPTION

The low aluminium door threshold is designed mainly for use in commercial properties. Allowing easier access to properties for wheelchair users & disabled people.

This option is not as effective at stopping draughts, and is not classed as draught proof like you would expect from a UPVC threshold, although still water proof.

It is best to speak with your representative to find the best solution for your property.

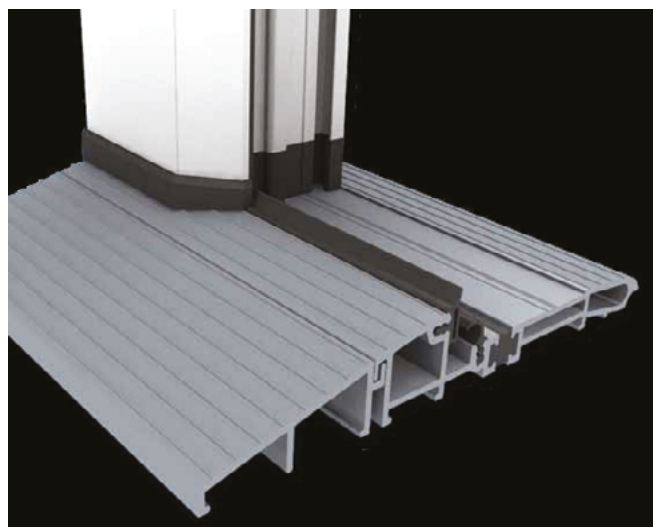

BACK DOOR OPTIONS



HALF LINCOLN
Ornate



HALF KENDAL
Ornate



HALF INVERTED
LINCOLN
Ornate

CONSERVATORY & HALF PANELS



TUDOR

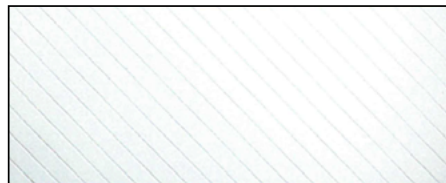

HERRINGBONE

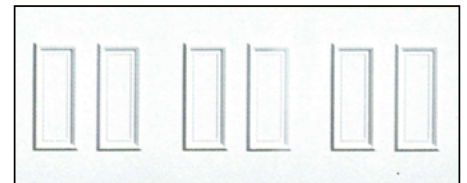

LINCOLN TRIPLE



BEVERLEY TRIPLE



KENDLE TRIPLE

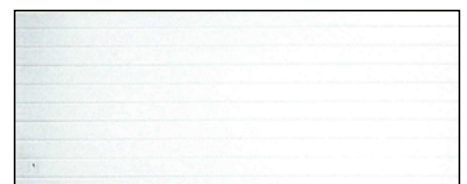

SHIPLAP B

CERTIFIED INSTALLATIONS

Derbyshire Trusted Trader has been set up for anyone else who worries about calling in traders or using businesses.

It aims to help combat rogue traders and door step crime, and to promote good standards of customer service and fair trading. It does this by supporting businesses that operate legally, fairly and honestly.

IWG has been providing Insurance Backed Guarantees for over 17 years and are the leading industries provider of premium service for the provision of Insurance Backed Guarantees.

FENSA are one of the industry leaders for allowing registered companies to self-certify that their installation comply with current Building Regulations.

PermaRoof Rubber Roofing is the UK's leading manufacturer and supplier of Rubber cover roofing, offering a 20 year guarantee and a 50 year life expectancy.



YOUR BUDGET

Whilst we endeavour to provide our customers with competitive prices we do use premium products when quoting, as a result our quotation may not be the cheapest if shopping around, please mention this to our team who can always suggest similar products that may suit a cheaper budget bracket.

DURING & AFTER INSTALLATION...



- We all ways use dust sheets.
- We Hoover up to a good standard after Installations.
- We use masking tape for sealing up with silicon to give the neatest finish possible.
- We are licensed waste carriers so the majority of the time skips are avoided.



- We know every installation can be different in regards to the finishing touches. We always keep good communication with our customers to ensure that all finishing is completed to the best standards, and that our customer is always happy with the finished result.



- All installations come with a 12-month after-care service. If you have any problems during this time, please contact us and we will do our best to resolve them within one week.
- We are committed to providing our customers with the best possible service, and we are confident that we can resolve any problems that you may have.

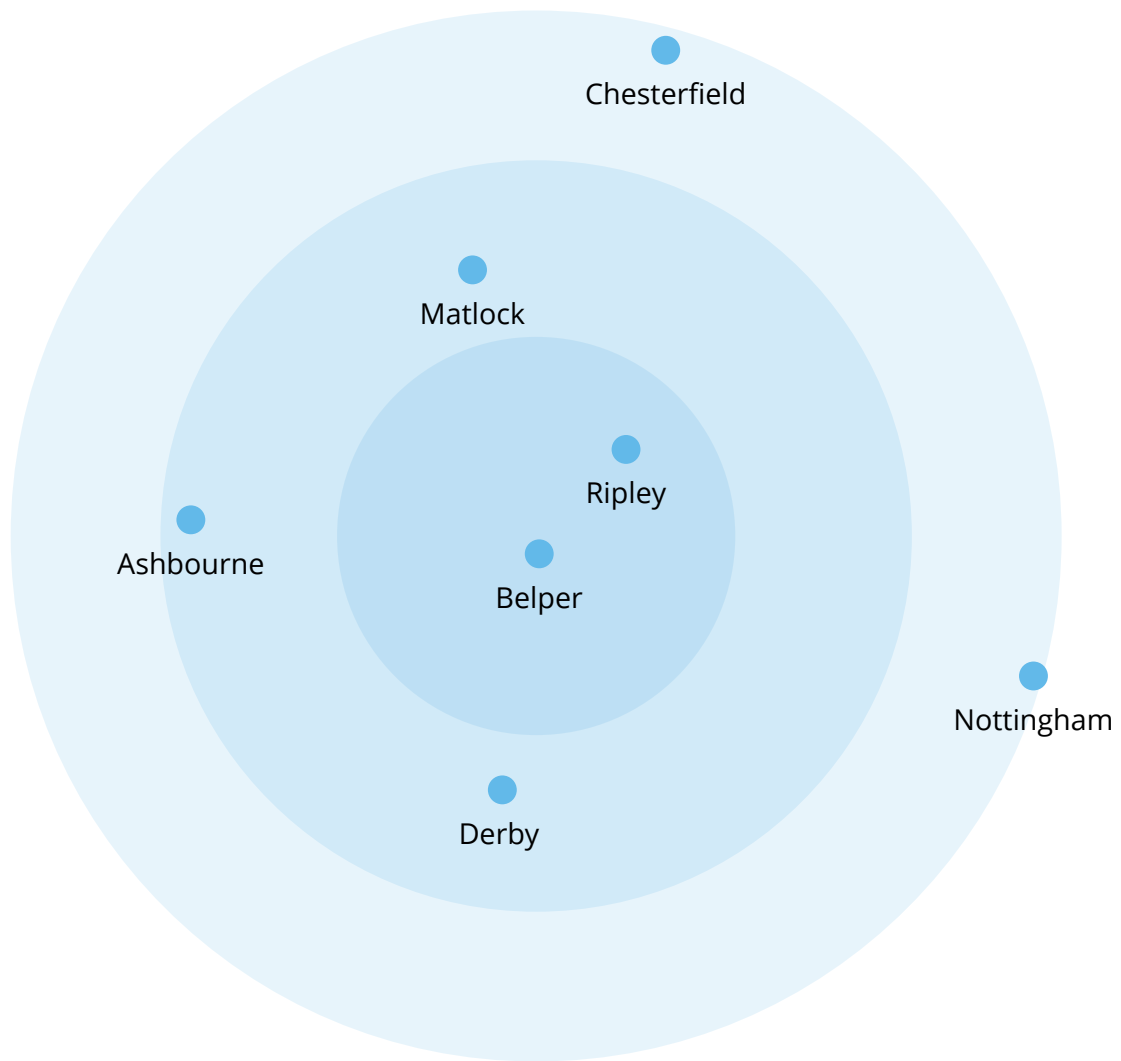

smartglaze

HOME IMPROVEMENTS LTD
ESTABLISHED 2004

*See our website or
email us
for more ideas...*



Call: 01332 780125

Denby, Derbyshire
Email: info@smartglaze.co.uk
www.smartglaze.co.uk

*Call us for a
chat about your
requirements...*



Office Hours:
Monday - Friday 9:30am - 5:00pm